

Alaska State Commission for Human Rights and Anchorage Equal Rights Commission

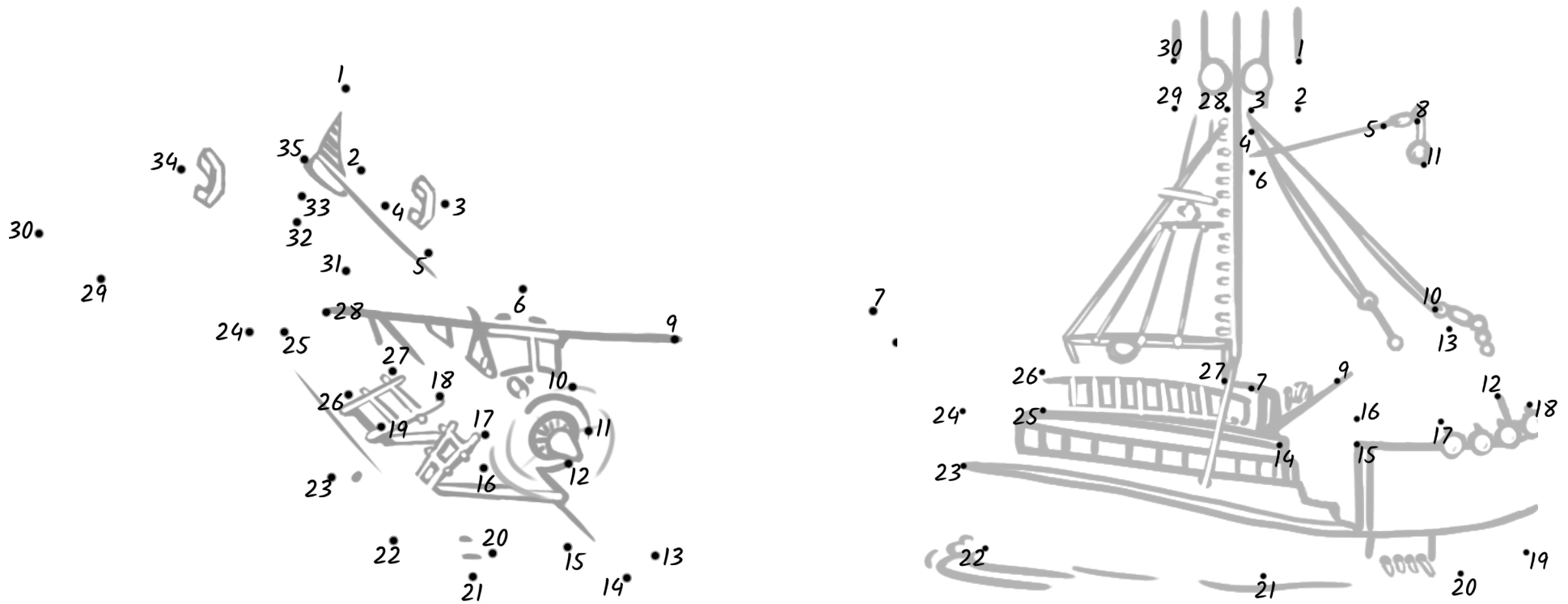

Activity Book for Every Age Group!

Alaska State Commission for Human Rights and Anchorage Equal Rights Commission

What we do...

What is the Alaska State Commission for Human Rights (ASCHR)?

The Alaska State Commission for Human Rights has statewide powers and investigates discrimination complaints to help defend and protect individuals all across the state of Alaska.

ASCHR Vision Statement

An Alaska free of discrimination.

What is the Anchorage Equal Rights Commission (AERC)?

The Anchorage Equal Rights Commission provides free and confidential services to the public in cases involving discrimination and harassment.

AERC Vision Statement

Justice - Peace - Equality

Did You Know?

In Alaska, it is illegal to discriminate in employment, public places, property sale and rental, financing, and practices by the State because of **race, color, religion, sex, national origin, or physical or mental disability**, and some instances of **age, marital status / changes, pregnancy, parenthood, or sexual orientation / gender identity or expression**.

Need help? Contact us.

Alaska State Commission for Human Rights (907) 274-4692 | Anchorage Equal Rights Commission (907) 343-4342

Maze

Can you find your way through the maze to embrace togetherness?

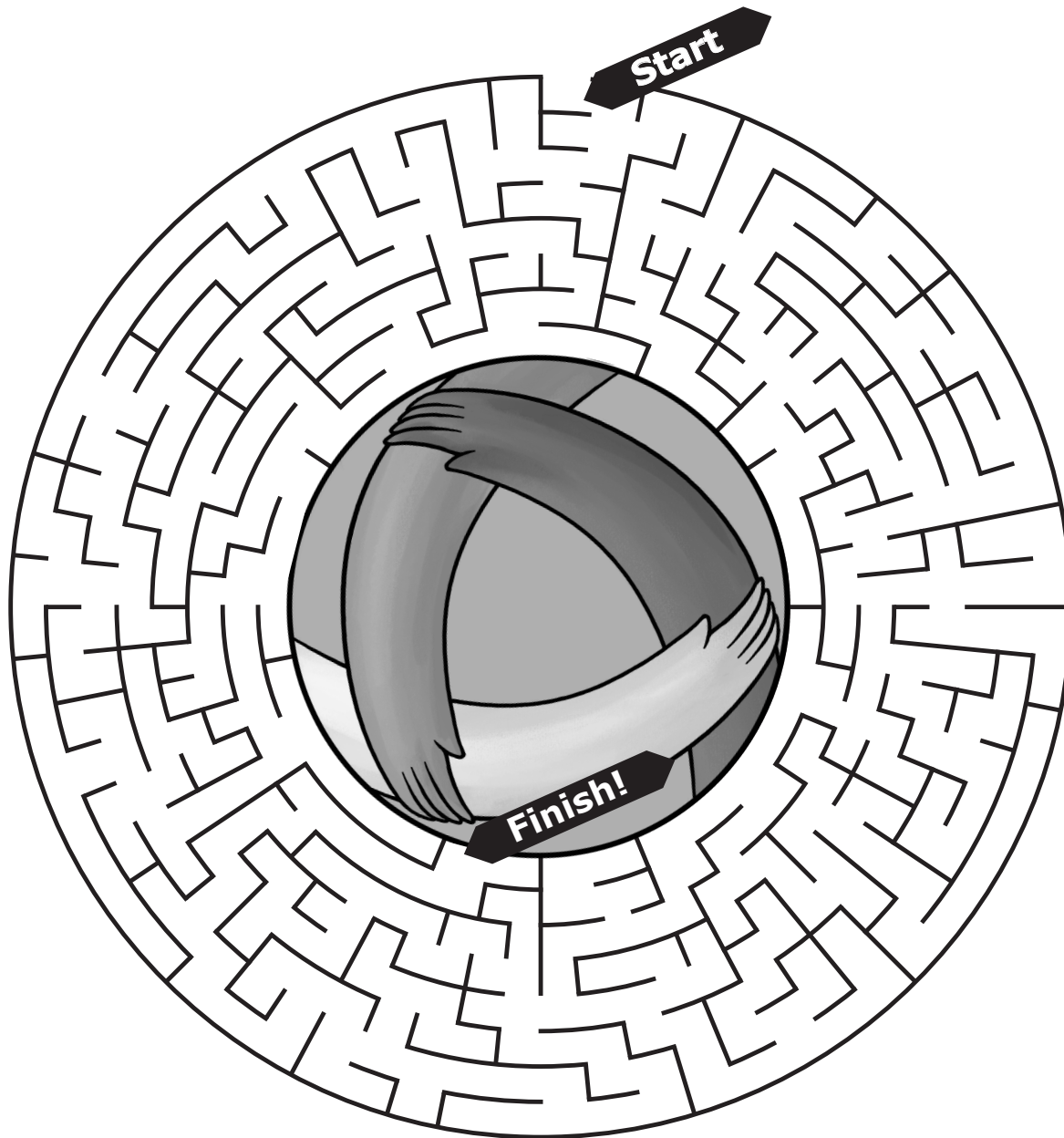

Celebrate

Celebrate each other's unique attributes together! Draw yourself or someone you know using the outline below.

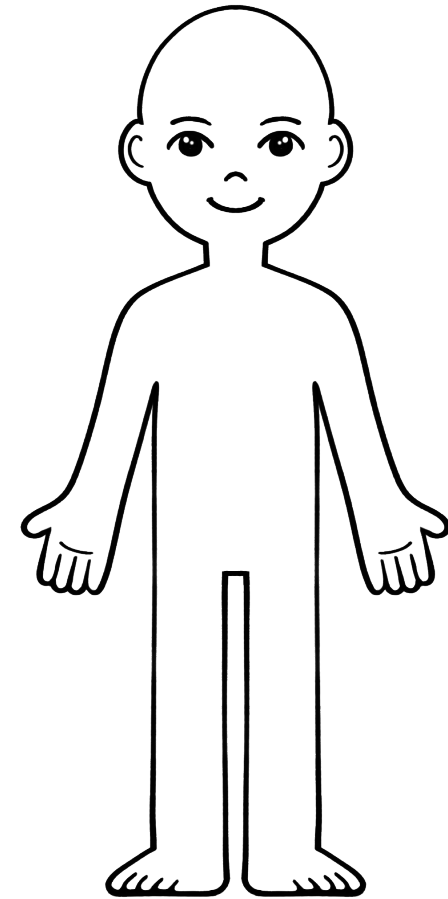

Share with a Friend

Today, try telling a friend something you enjoy about them.

Word Search

Can you find some terms that represent human rights in Alaska?



T	C	H	W	C	Z	B	Y	Q	W																				
R	N	H	H	U	O	T	K	V	W	F	A	C	V																
Z	B	I	U	F	Z	M	F	O	Q	Y	U	N	I	V	E	R	S	A	L										
X	F	D	H	G	L	Z	M	A	X	R	E	R	N	O	H	L	A	R	V	B	J	T	D						
A	C	K	B	D	H	F	I	P	N	Q	N	N	P	P	I	O	Y	G	J	X	U	R	H	S	G				
C	K	J	Q	E	B	R	T	S	R	E	L	I	G	I	O	N	T	G	R	R	S	J	Y	K	A	U	U	W	O
I	D	H	F	X	G	J	J	S	R	O	S	E	O	L	Z	A	E	M	I	U	O	T	F	S	D	A	P	I	U
V	Y	V	P	C	G	L	R	I	U	O	Z	S	R	D	T	C	S	L	G	W	K	P	A	A	J	C	P	L	C
I	F	C	H	A	W	B	I	O	X	Y	W	M	S	N	V	Z	A	M	I	R	A	T	P	T	C	E	O	J	G
L	V	L	O	E	R	M	C	N	X	J	D	Q	E	P	K	U	K	T	N	C	F	S	R	F	E	G	R	W	J
Z	V	I	Y	N	K	E	A	D	K	N	R	I	N	L	Q	I	U	N	V	E	L	O	V	E	Z	V	T	P	O
X	L	F	I	K	S	B	N	R	B	Y	R	F	S	E	S	O	P	J	X	E	X	P	R	E	S	S	I	O	N
Y	E	Y	A	Z	W	T	J	T	R	O	C	H	H	A	P	P	I	N	E	S	S	U	L	O	W	L	H	Z	O
D	Q	B	I	P	Y	I	I	H	I	O	Q	I	B	T	T	Q	H	S	T	X	H	T	V	R	N	R			
K	P	N	Z	R	R	C	T	D	O	A	B	M	A	T	I	D	I	G	N	I	T	Y	X	P	F	B	L		
F	G	A	M	N	E	G	U	E	O	G	F	M	G	M	L	C	U	Q	R	F	S	Y	E	I	O				
T	N	Z	C	E	G	G	T	N	D	E	W	U	E	H	I	R	E	S	P	E	C	T	V						
A	F	E	I	S	N	F	I	T	H	U	E	N	A	B	T	O	V	R	X	U	D								
L	M	F	A	S	A	Y	O	I	R	P	T	I	B	L	Y	M	Z	E	S										
A	A	P	Z	E	N	X	N	T	U	A	R	T	L	V	Y	V	W												
S	Q	F	I	W	C	Q	K	Y	L	N	N	Y	W	D	W														
K	J	I	I	I	Y	H	B	H	E	E	X	U	M																
A	I	I	R	S	Q	A	E	E	B	M	J																		
R	C	I	T	Q	A	A	Q	A	H																				
S	E	G	X	O	L	Y	J																						
H	Y	E	Y	T	W																								
Y	A	H	H																										
K	S																												



- | | | | |
|--------------|--------------|----------|------------|
| AGE | ALASKA | CIVIL | COMMISSION |
| COMMUNITY | CONSTITUTION | DIGNITY | DISABILITY |
| EQUAL | EXPRESSION | FAIRNESS | HAPPINESS |
| HUMAN | IDENTITY | LOVE | MARRIAGE |
| MENTALHEALTH | ORIENTATION | ORIGIN | PARENTHOOD |
| PREGNANCY | RELIGION | RESPECT | RIGHTS |
| SEX | STATE | SUPPORT | UNIVERSAL |



Chinook (King) Salmon



Coho (Silver) Salmon

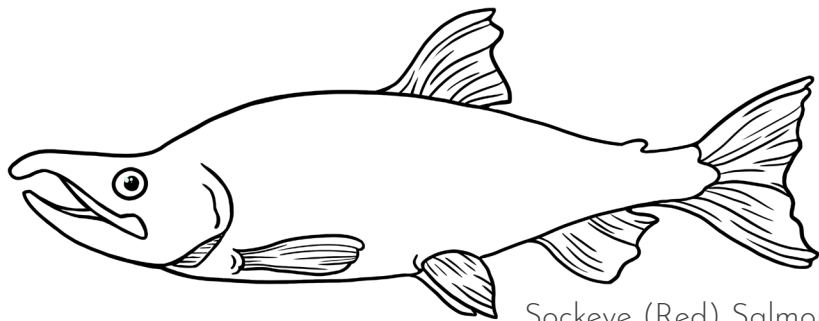

Sockeye (Red) Salmon



Pink (Humpy) Salmon

Salmon Facts

Did you know? There are five species of salmon found in Alaska. Salmon change from **silver** to **bright colors** when they return from the ocean to the rivers where they were born. These are called their "spawning" colors.

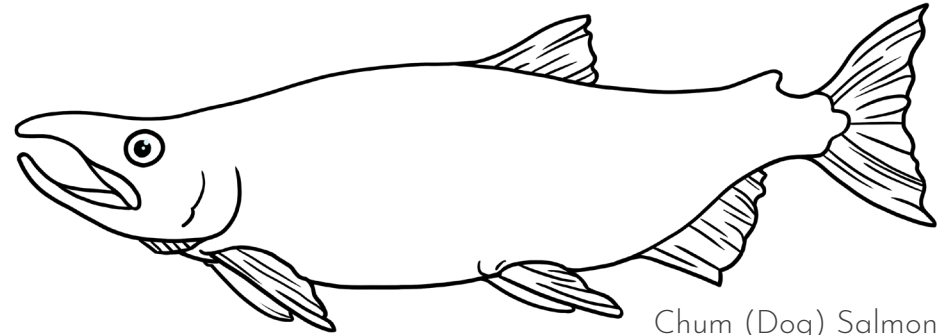

Chum (Dog) Salmon

Draw and Color

All five salmon are different, but they are all fish who share the same home - Alaska. There are lots of kinds and colors of people, just like salmon. Color these salmon and consider drawing your own below!



Visual Language

Sign Language is a visual language that uses hand shapes, facial expressions, gestures, and body languages. American Sign Language (ASL) has it's own vocabulary, construction and grammer that isn't necessarily the same as the English language. But it is not as difficult to learn as it may look!

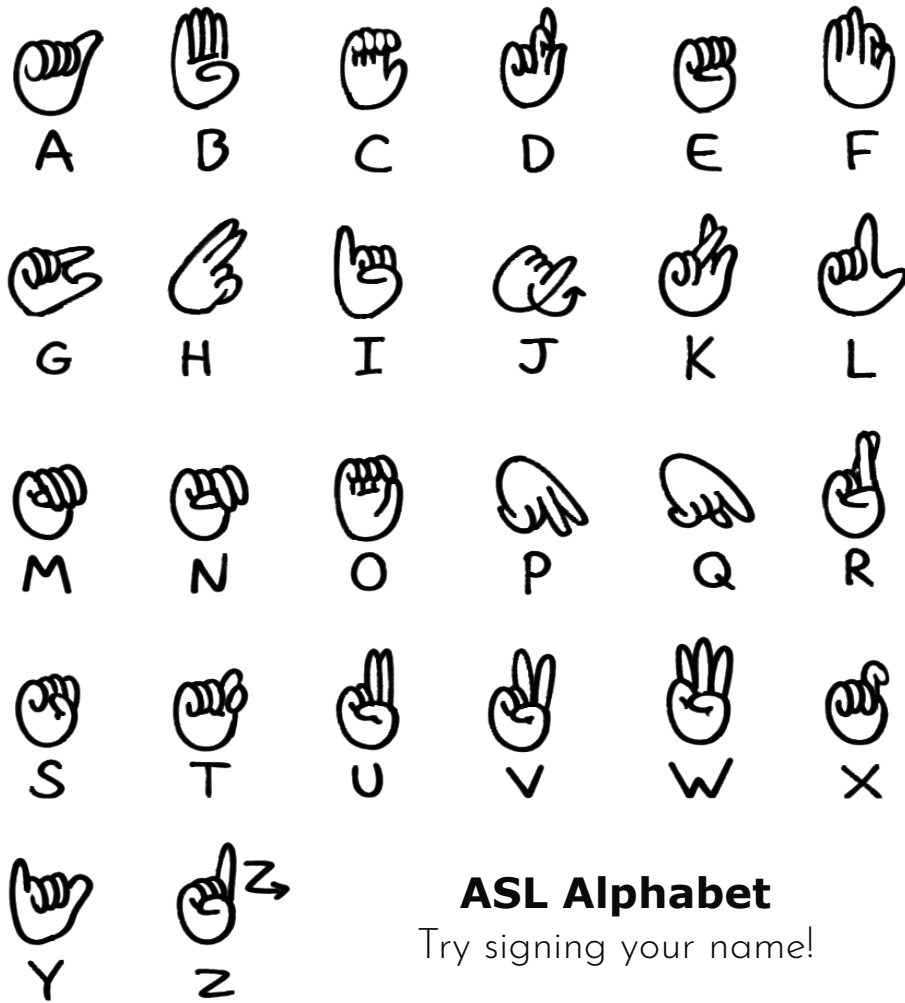

ASL Alphabet

Try signing your name!

Decode

Use the ASL alphabet to decipher this statement.

No

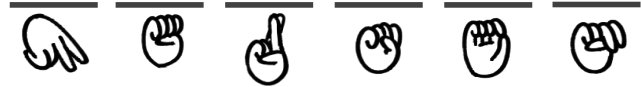

is to be denied the



of any

or political



because of race,



color, creed, sex, or national

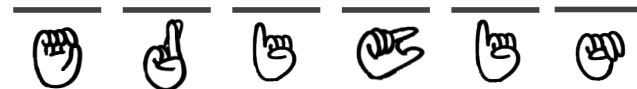

Answer: No person is to be denied the enjoyment of any civil or political right because of race, color, creed, sex, or national origin

Matching

Can you match the religious symbols to their names below?

- **9-pointed Star** (Baha'i Faith)
- **Dharmachakra** (Hinduism & Buddhism)
- **Latin Cross** (Christianity)
- **Confucius** (Confucianism)
- **Aum Om** (Hinduism)
- **Star and Crescent** (Islam)
- **Ahimsā** (Jainism)
- **Native American Church** (Peyotism)
- **7-branched Menorah** (Judaism)
- **Circle** (Polytheism)
- **Khanda** (Sikhism)
- **Yin Yang** (Taoism & Confucianism)
- **Flaming Chalice** (Unitarianism & Unitarian Universalism)
- **Faravahar** (Zoroastrianism)

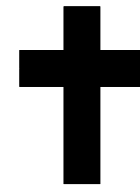
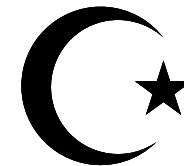
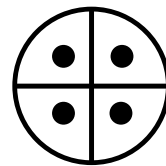
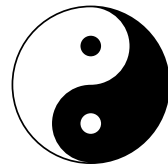
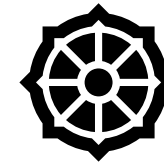
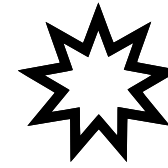

Freedom
Religious liberty
encompasses the right to freely
exercise religion or belief.

Iconography
Religious symbolism and
iconography are artistic forms
and gestures that convey
religious concepts of humanity's
relationship to the sacred, holy,
and the social and material world.

Puzzle Color

Assign a color of your choice to one or more of the boxes for each protected class, then apply those colors to the Human Rights puzzle below. We all fit together; we are all part of the Alaska community.

- Race
- Color
- Religion
- Sex
- National Origin
- Physical Disability
- Mental Disability
- Age
- Marital Status
- Marital Changes
- Pregnancy
- Parenthood
- Sexual Orientation
- Gender Identity
- Gender Expression



Funded by the Alaska State Commission for Human Rights & the Anchorage Equal Rights Commission; Printed by Reprographics; Layout and content by Elysian World Editing (www.elysianWE.com); Illustrations by Ginger Cooley (www.iamcooley.com)

